



INFORME TÉCNICO SOBRE LA OPERACIÓN DEL RELLENO SANITARIO DE QUITO

EMGIRS-EP

ENERO 2013

1. INGRESO MENSUAL DE RESIDUOS SOLIDOS AL RELLENO SANITARIO DE EL INGA

ENERO 2013					
DIA	FECHA	DISTR. (Ton)	RUMIÑAH. (Ton)	HOSPITAL. (Ton)	TOTAL (Ton)
M	01/01/2013	810,58	49,55	0,00	860,13
M	02/01/2013	2.217,46	57,08	9,48	2.384,02
J	03/01/2013	2.649,24	122,43	1109	2.782,76
V	04/01/2013	2.453,70	130,92	4,74	2.589,36
S	05/01/2013	1.905,36	72,85	2,45	1.980,66
D	06/01/2013	869,51	87,88	0,00	957,39
L	07/01/2013	1.559,55	125,79	10,39	1.695,73
M	08/01/2013	2.435,10	120,60	9,58	2.565,28
M	09/01/2013	1.893,38	111,18	12,54	2.017,10
J	10/01/2013	1.663,40	97,93	1137	1.772,70
V	11/01/2013	1.722,55	108,87	7,99	1.839,41
S	12/01/2013	1.825,83	72,46	0,00	1.898,29
D	13/01/2013	834,37	102,22	0,00	936,59
L	14/01/2013	1.548,63	114,81	12,31	1.675,75
M	15/01/2013	2.584,49	95,97	10,50	2.690,96
M	16/01/2013	2.134,43	128,78	9,75	2.322,96
J	17/01/2013	1.732,34	72,32	10,07	1.814,73
V	18/01/2013	1.721,24	113,90	8,68	1.843,82
S	19/01/2013	1.893,36	89,57	0,00	1.982,93
D	20/01/2013	767,61	109,49	0,00	877,10
L	21/01/2013	1.576,77	119,43	12,61	1.708,81
M	22/01/2013	2.423,84	115,69	10,53	2.550,06
M	23/01/2013	1.840,45	121,37	12,04	1.973,86
J	24/01/2013	1.671,33	98,60	8,70	1.778,63
V	25/01/2013	1.775,65	100,41	8,19	1.884,25
S	26/01/2013	1.768,33	71,48	0,00	1.839,81
D	27/01/2013	764,19	80,40	0,00	844,59
L	28/01/2013	1.605,83	114,12	12,56	1.732,51
M	29/01/2013	2.533,85	116,68	12,37	2.702,90
M	30/01/2013	1.899,60	100,45	10,55	2.010,60
J	31/01/2013	1.629,46	75,68	1180	1.716,94
TOTAL (Ton)		54.761,43	3.238,91	230,29	58.230,63
PROMEDIO (Ton)		1.766,50	104,48	7,43	1.878,41

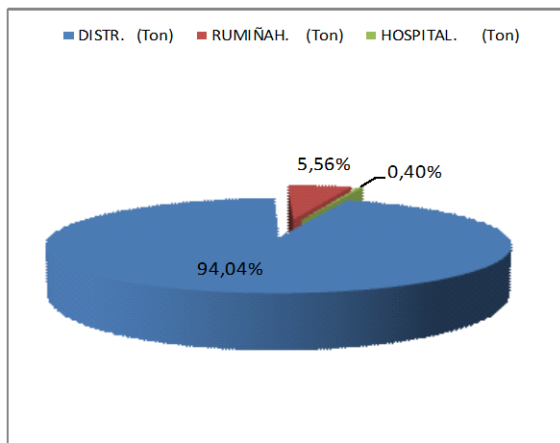
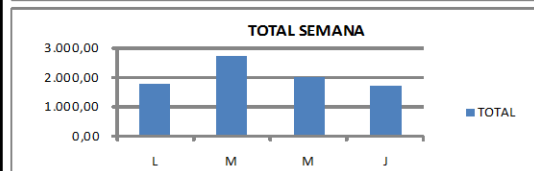
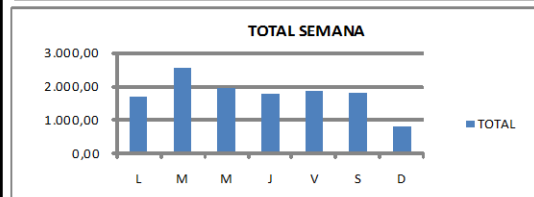
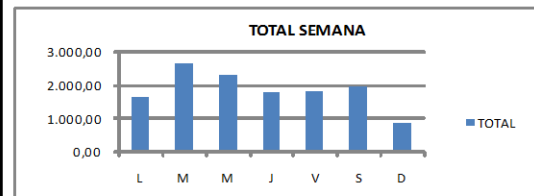
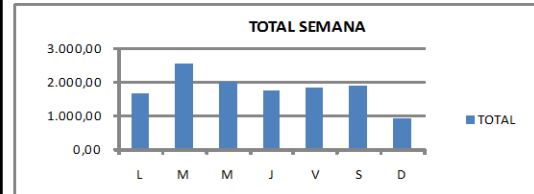
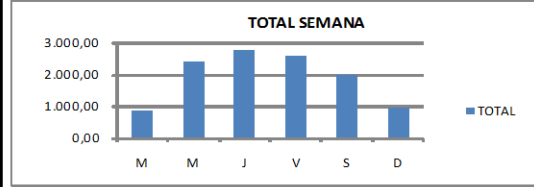

DIA	PROMEDIO
LUNES	1703,20
MARTES	2.273,87
MIÉRCOLES	2.111,71
JUEVES	1.973,15
VIERNES	2.039,21
SABADO	1.925,42
DOMINGO	903,92

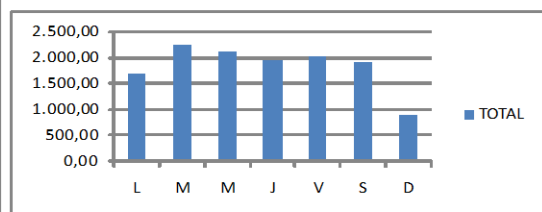

1.1 CONDENSADO MENSUAL

DISPOSICION RSU EN RELLENO SANITARIO - AÑO 2013				
MES	DISTRITO (Ton)	RUMIÑAHUI (Ton)	HOSPITALARIOS (Ton)	TOTAL (Ton)
Enero	54.761,43	3238,91	230,29	58.230,63
Febrero				
Marzo				
Abril				
Mayo				
Junio				
Julio				
Agosto				
Septiembre				
Octubre				
Noviembre				
Diciembre				
TOTAL (Ton)	54.761,43	3.238,91	230,29	58.230,63
PROMEDIO (Ton)	54.761,43	3.238,91	230,29	58.230,63



2. ESTACIONES DE TRANSFERENCIA

ET NORTE

DIA	EMASEO (TON)	PARTICULARES (TON)	TRANSPORTADO (TON)	RECICLADO (TON)	TOTAL	
					INGRESADO (TON)	SALIDA (TON)
mar-01	423,95	0,60	513,96	-	424,55	513,96
mié-02	1.650,48	-	1.148,54	-	1.650,48	1.148,54
jue-03	1.697,93	-	1.288,13	16,76	1.697,93	1.304,89
vie-04	1.335,75	-	1.307,71	9,11	1.335,75	1.316,82
sáb-05	1.244,24	7,53	1.026,74	-	1.251,77	1.026,74
dom-06	423,48	-	471,04	-	423,48	471,04
lun-07	1.239,50	0,75	806,16	10,97	1.240,25	817,13
mar-08	1.600,20	5,55	1.224,11	17,85	1.605,75	1.241,96
mié-09	1.178,30	13,91	1.010,93	32,29	1.192,21	1.043,22
jue-10	1.044,20	7,26	857,53	19,44	1.051,46	876,97
vie-11	1.121,09	5,63	975,43	24,97	1.126,72	1.000,40
sáb-12	1.139,88	8,92	959,66	-	1.148,80	959,66
dom-13	379,95	41,73	452,56	-	421,68	452,56
lun-14	1.115,30	19,09	780,46	9,67	1.134,39	790,13
mar-15	1.431,21	13,86	1.434,61	16,47	1.445,07	1.451,08
mié-16	1.010,51	12,21	1.263,59	13,02	1.022,72	1.276,61
jue-17	935,11	12,18	900,49	35,39	947,29	935,88
vie-18	1.004,63	15,20	947,27	21,40	1.019,83	968,67
sáb-19	1.064,47	9,34	1.031,31	2,96	1.073,81	1.034,27
dom-20	353,68	31,08	403,49	-	384,76	403,49
lun-21	1.021,27	25,43	917,79	15,59	1.046,70	933,38
mar-22	1.356,15	14,31	1.265,12	26,34	1.370,46	1.291,46
mié-23	959,48	10,29	972,78	24,53	969,77	997,31
jue-24	944,38	10,35	878,71	12,71	954,73	891,42
vie-25	956,07	15,70	954,58	21,45	971,77	976,03
sáb-26	1.045,41	7,09	959,21	2,14	1.052,50	961,35
dom-27	300,65	28,84	371,93	-	329,49	371,93
lun-28	1.051,39	15,29	966,19	30,87	1.066,68	997,06
mar-29	1.301,69	26,31	1.213,54	25,48	1.328,00	1.239,02
mié-30	956,24	14,40	955,50	14,01	970,64	969,51
jue-31	902,11	11,44	865,79	12,38	913,55	878,17
TOTAL	32.188,70	384,29	29.124,86	415,80	32.572,99	29.540,66

Fuente: Información proporcionada por Fiscalización de la EMGIRS-EP

ET SUR

DIA	EMASEO (TON)	PARTICULARES (TON)	TRANSPORTADO (TON)	TOTAL	
				INGRESADO (TON)	SALIDA (TON)
mar-01	276,60	-	357,80	276,60	357,80
mié-02	969,51	-	1.075,64	969,51	1.075,64
jue-03	1.269,62	5,19	1.056,17	1.274,81	1.056,17
vie-04	794,10	6,92	1.005,41	801,02	1.005,41
sáb-05	713,46	4,40	746,78	717,86	746,78
dom-06	224,36	3,73	292,74	228,09	292,74
lun-07	780,35	-	682,05	780,35	682,05
mar-08	1.009,90	1,82	1.044,78	1.011,72	1.044,78
mié-09	746,31	8,03	753,12	754,34	753,12
jue-10	563,51	9,68	626,57	573,19	626,57
vie-11	750,74	0,77	672,66	751,51	672,66
sáb-12	686,14	1,46	746,62	687,60	746,62
dom-13	242,94	5,12	279,73	248,06	279,73
lun-14	761,34	0,45	643,69	761,79	643,69
mar-15	987,33	1,19	999,48	988,52	999,48
mié-16	778,59	5,73	750,81	784,32	750,81
jue-17	591,37	8,55	675,26	599,92	675,26
vie-18	783,40	5,67	737,39	789,07	737,39
sáb-19	692,97	3,93	756,49	696,90	756,49
dom-20	256,93	3,92	272,52	260,85	272,52
lun-21	704,28	0,09	628,19	704,37	628,19
mar-22	977,01	1,34	1.021,78	978,35	1.021,78
mié-23	733,47	4,99	735,90	738,46	735,90
jue-24	563,80	8,57	598,92	572,37	598,92
vie-25	669,48	18,98	611,77	688,46	611,77
sáb-26	716,43	5,37	763,74	721,80	763,74
dom-27	234,50	8,60	292,73	243,10	292,73
lun-28	732,76	3,93	655,05	736,69	655,05
mar-29	971,04	5,14	943,56	976,18	943,56
mié-30	723,95	4,15	747,30	728,10	747,30
jue-31	557,13	2,34	633,63	559,47	633,63
TOTAL	21.463,32	140,06	21.808,28	21.603,38	21.808,28

Fuente: Información proporcionada por Fiscalización de la EMGIRS-EP

3. VOLUMEN DIARIO/ MENSUAL DE LIXIVIADO EXTRAÍDO Y TRATADO.

Enero 2013

RESUMEN DE LOS VOLUMENES DE LAS PISCINAS Y VOLUMENES TRATADOS

FECHA	VOLUMEN ACUMULADO (m3)	VOLUMEN INGRESADO (m3)	VOLUMEN TRATADO (m3)	VOLUMEN ACUMULADO (m3)
01/01/2013	89.669,14	0,00	0,00	0,00
02/01/2013	89.524,52	323,83	96,29	227,54
03/01/2013	89.314,95	311,90	107,28	204,62
04/01/2013	89.207,74	327,03	50,97	276,06
05/01/2013	89.172,83	328,39	101,37	227,02
06/01/2013	89.105,97	315,76	0,00	315,76
07/01/2013	88.971,33	354,96	107,47	247,49
08/01/2013	88.792,27	315,93	114,07	201,86
09/01/2013	88.638,19	353,51	127,27	226,24
10/01/2013	88.503,15	351,00	105,59	245,41
11/01/2013	87.990,86	348,69	117,54	231,15
12/01/2013	87.896,21	384,58	102,51	282,07
13/01/2013	87.795,69	336,62	61,27	275,35
14/01/2013	87.700,16	331,29	49,21	282,08
15/01/2013	87.739,55	350,00	185,64	164,36
16/01/2013	87.564,00	396,94	197,40	199,54
17/01/2013	87.357,10	357,93	189,39	168,54
18/01/2013	87.123,29	320,37	178,49	141,88
19/01/2013	86.974,19	335,43	110,82	224,61
20/01/2013	86.900,07	355,52	55,94	299,58
21/01/2013	86.756,34	299,84	70,17	229,67
22/01/2013	86.574,14	313,33	125,12	188,21
23/01/2013	86.411,78	330,23	152,17	178,06
24/01/2013	86.103,82	211,17	158,55	52,62
25/01/2013	86.379,43	268,03	159,49	108,54
26/01/2013	86.210,63	294,11	111,50	182,61
27/01/2013	86.076,07	289,35	57,97	231,38
28/01/2013	86.014,55	391,79	89,12	302,67
29/01/2013	85.783,80	302,60	169,68	132,92
30/01/2013	85.076,21	308,48	139,70	168,78
31/01/2013	84.402,76	300,10	171,33	128,77

En este periodo se reportan los volúmenes tratados en la Planta de Tratamiento MBR, la Planta de Tratamiento VSEP se encuentra realizando pruebas de arranque por tanto no se realiza ningún registro.

4. FLUJOGRAMA DE LIXIVIADOS Enero 2013

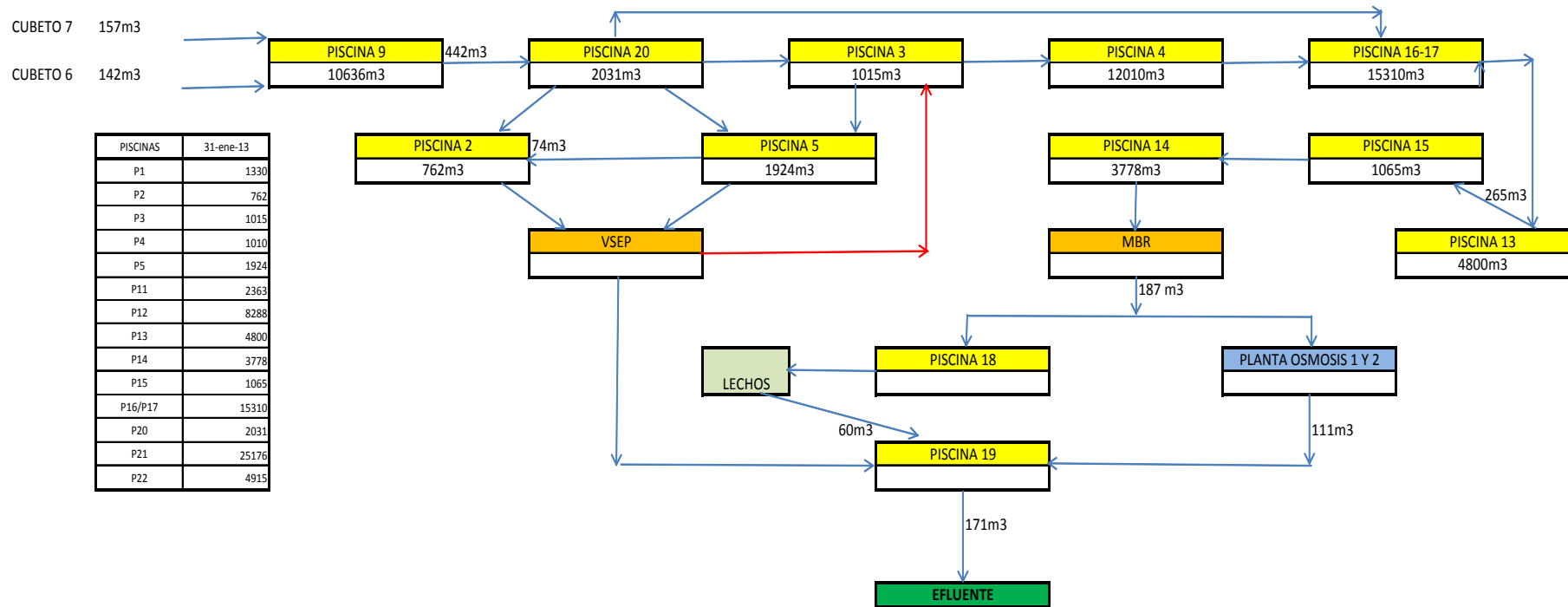

5. VOLUMEN ALMACENADO EN CADA UNA DE LAS PISCINAS, TOTAL AL FIN DEL PERÍODO REPORTADO.

Volumenes de Lixiviado en metros cúbicos (m3) almacenados en			
Piscina	Volumen a cota de desborde (m3)	Volumen a cota de seguridad (m3)	VOLUMENES DE LIXIVIADOS (m3)
			ENERO
P1	1.698,76	1.235,17	1.369,84
P2	816,86	688,23	729,16
P3	1.284,23	742,99	975,59
P4	1.154,77	974,17	1.026,12
P5	2.150,35	1.899,38	1.784,88
P9	23.459,23	22.905,73	13.609,70
P11	2.615,75	2.344,35	2.396,32
P12	9.132,00	8.294,77	8.487,10
P13	5.750,98	5.215,48	5.145,25
P14	3.979,95	3.781,47	3.776,82
P15	1.127,23	1.008,42	1.098,39
P16/P17	15.985,68	13.888,91	15.152,57
P20	2.995,64	2.710,72	1.105,44
P21	30.162,11	27.912,89	25.121,05
P22	5.069,57	4.731,95	4.947,91
TOTALES	107.383,12	98.334,63	86.726,14

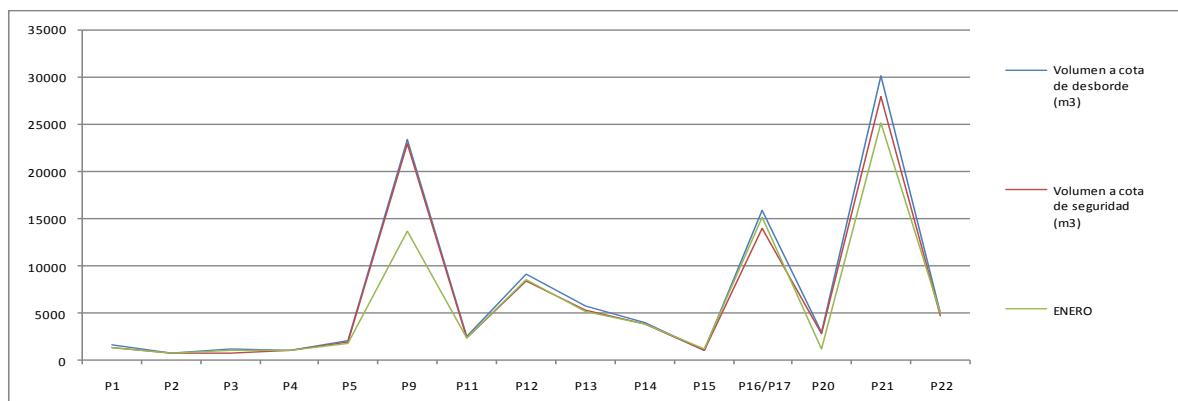
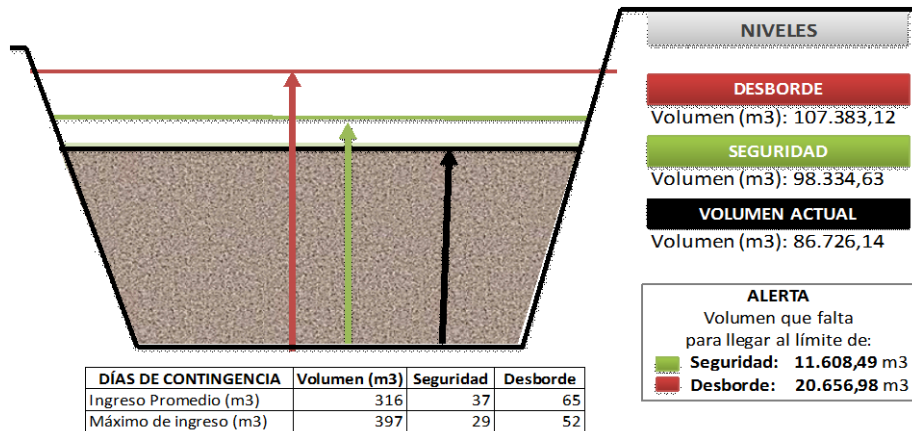

**6. CARACTERÍSTICAS FÍSICO – QUÍMICAS DEL LIXIVIADO EN CADA UNA DE LAS PISCINAS
Enero 2013**

PISCINAS	DQO, mg/L	DBO, mg/L
9 IN	83266	35150
9 OUT	15629	4240
20	13822	9000
3	10989	4300
4	6437	1824
16-17	4861	1056
5	2,908	1642

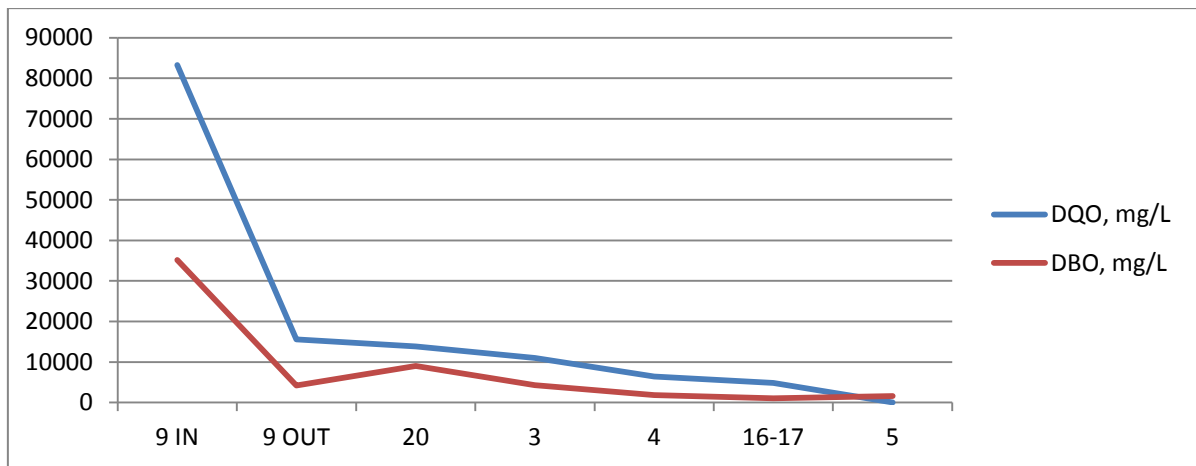

PISCINAS	CONDUCT, us
9	45000
20	40000
16-17	30200

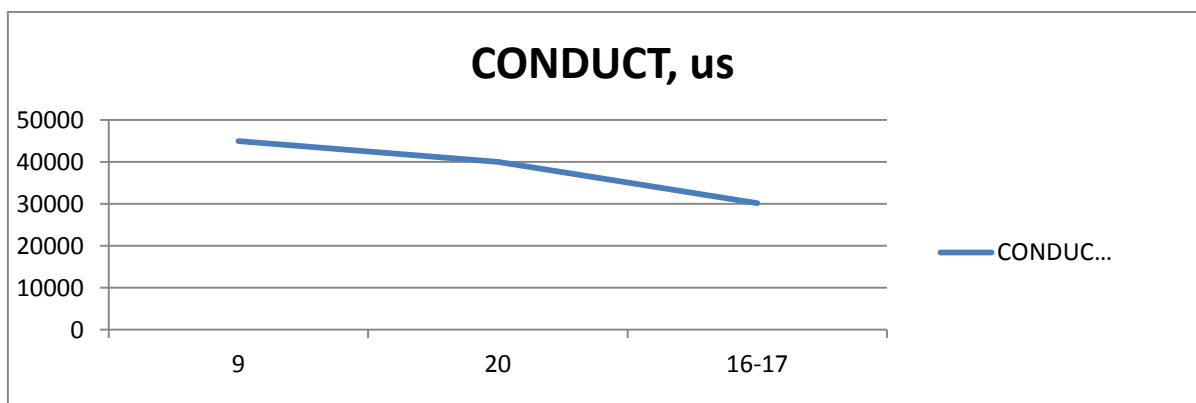

7. TRATAMIENTO DE RESIDUOS HOSPITALARIOS

Enero 2013

CALENDARIO ENERO 2013		PESO EN KILOS		USUARIOS RECOLECTADOS
		CARGA INGRESADA	CARGA TRATADA	
		REGISTRO DE BASCULA R.S.	DISP. FINAL R.S REGISTRO DE BASCULA	
M	1	0,00	0,00	0
MI	2	13.950,00	9.480,00	31
J	3	9.930,00	11.090,00	99
V	4	9.420,00	4.740,00	92
S	5	0,00	2.450,00	0
D	6	0,00	0,00	0
L	7	15.360,00	10.390,00	112
M	8	12.350,00	9.580,00	131
MI	9	11.860,00	12.540,00	132
J	10	9.680,00	11.370,00	110
V	11	8.400,00	7.990,00	58
S	12	0,00	0,00	0
D	13	0,00	0,00	0
L	14	16.610,00	12.310,00	84
M	15	11.923,00	10.500,00	113
MI	16	10.490,00	9.750,00	143
J	17	9.250,00	10.070,00	109
V	18	9.450,00	8.680,00	101
S	19	0,00	0,00	0
D	20	0,00	0,00	0
L	21	14.180,00	12.610,00	65
M	22	11.030,00	10.530,00	90
MI	23	9.670,00	12.040,00	93
J	24	10.000,00	8.700,00	80
V	25	9.120,00	8.190,00	86
S	26	0,00	0,00	0
D	27	0,00	0,00	0
L	28	14.750,00	12.560,00	63
M	29	10.630,00	12.370,00	123
MI	30	10.500,00	10.550,00	123
J	31	8.820,00	11.800,00	102
TOTAL MES		247.373,00	230.290,00	2.140,00